



**GUIDELINES
FOR USE**

**RE PS
02-001-2011**

**USE OF
TMK UP FMT THREAD CONNECTION FOR TUBING**

Revision 9

Introduction

The present guidelines are worked out taking into account the requirements of the following documents:

- API RP 5C1 Recommended Practice for Care and Use of Casing and Tubing;
- API RP 5B1 Gaging and Inspection of Casing, Tubing and Pipe Line Threads;
- ISO 10405 Petroleum and Natural Gas Industries – Care and Use of Casing and Tubing.
- TR CU 010/2011 – Technical Regulations of EAEC “on the Safety of Machinery and Equipment”.

Information about the guidelines for use

1 APPROVED BY

Director of Development

TMK - Premium Services LLC

 A.S. Myslevtsev

June 18, 2021

2 DEVELOPED BY Serial Design Bureau

3 Revision 9. Effective date is July 18, 2021 with an option of early use.

4 For replacement of Revision 8 introduced into effect in February 01, 2018.

5 This revision contains over 25 % changes and additions as compared to the previous revision and amendments, thus there are no highlighted places in the text.

Contents

1	Scope	1
2	Normative references.....	1
3	Terms and definitions.....	2
4	Transportation, handling operations and storage	2
4.1	Transportation	2
4.2	Handling operations.....	3
4.3	Stockholding and storage	4
5	Preparation of pipes for make-up	5
5.1	General provisions.....	5
5.2	Visual inspection.....	5
5.3	Thread protectors' removal	6
5.4	Compound removal	6
5.5	Thread connection inspection	7
5.6	Drifting	9
5.7	Measurement of length of pipes.....	10
5.8	Thread protectors' installation	11
6	Make-up of pipes	11
6.1	Application of thread compound.....	11
6.2	Running and pulling	14
6.3	Assembly of string	16
6.4	Make-up inspection by the make-up diagram.....	21
6.5	Break-out of string	26
6.6	Make-up inspection by make-up triangle	28
7	Developer's warranty	28
	Annex A (mandatory) Equipment for make-up registration	29
	Annex B (mandatory) Requirements to safety upon tubing operation	30

USE OF TMK UP FMT THREAD CONNECTION FOR TUBING

Effective date 18 -07-2021

1 Scope

The present guidelines contain recommendations for maintenance and use of tubing with TMK UP FMT thread connection under field conditions, including pipe preparation and make-up, string running and pulling operations, as well as guidelines for pipe handling, storage and inspection during operation.

2 Normative references

The present guidelines contain normative references to the following documents:

GOST R ISO 13678 Casing, Tubing, Pipe Line and Elements of Drill Strings for Oil and Gas Industry;

GOST 15150-69 Machines, Instruments and Other Industrial Products. Modifications for Different Climatic Regions. Categories, Operating, Storage and Transportation Conditions as to Environment Climatic Aspects Influence.

- API RP 5A3/ISO 13678 Recommended Practice on Thread Compounds for Casing, Tubing and Line Pipe;

RD 39-7-904-83 Instruction on Material, Equipment and Spare Parts Storage in Warehouses on Facilities of Production and Technical Servicing and Completing, Enterprises and Entities of Ministry of Oil Industry-

TU 0254-001-46977243-2002 RUSMA-1, RUSMA-1 (3) Thread Compounds;

TU 0254-031-46977243-2004 RUSMA R-4, RUSMA R-4 (3) Thread Compounds;

TU 0254-068-46977243-2009 RUSMA R-14, RUSMA R-14 (3) Special Thread Compound;

TU 19.20.29-223-46977243-2018 RUSMA API Modified 1000 Thread Compound;

TU 0254-167-46977243-2015 RUSMA API Modified Thread Compound;

TU 0254-158-46977243-2013 RUSMA Storage Compound;

TU 19.20.29-250-46977243-2018 RUSMA-M3 Thread Compound.

Note – The specified document revision shall be applied for dated references.

3 Terms and definitions

For the purposes of the present guidelines the standard terms as well as the following terms and definitions shall be applied:

- 3.1 **rotation on shoulder:** Preset movement of thread connection in circumferential direction after thread connection surfaces shouldering.
- 3.2 **box (box connection):** The product with a thread connection on an inside surface.
- 3.3 **pin (pin connection):** The end of pipe with a thread connection on an outside surface.
- 3.4 **thread connection (make-up result):** Make-up of pin and coupling by means of thread.
- 3.5 **thread connection (structural element):** Thread, seals, shoulders and other auxiliary elements of structure on pin or coupling.
- 3.6 **thread seals:** Pin sealing groove and coupling sealing bore ensuring tightness of thread connection upon pin and coupling make-up.
- 3.7 **thread shoulders:** Pin shoulder and box shoulder acting as an arrester upon pin and coupling make-up.

4 Transportation, handling operations and storage

4.1 Transportation

4.1.1 When pipes are transported by sea, railroad (railcars) or trucks, Cargo Shipping Rules and Technical Provisions for Cargo Handling and Fastening applicable to the particular transport type shall be observed.

4.1.2 Pipe transportation, handling and storage shall be carried out with thread protectors screwed on pin and coupling end faces in order to protect thread surface, thread shoulders and thread seals from exposure.

4.1.3 Pipe bundles of different lots and standard sizes can be loaded into same means of transportation, but have to be separated.

4.1.4 Pipe bundles shall be securely fastened during transportation to avoid any movement. Wooden blocks can be used for fastening purposes.

When several pipes bundles are stacked or not bundled pipes are stacked into several ranks, pipe bundles and pipe ranks shall be separated by at least three wooden blocks, with the thickness from 1.3780 to 1.5748 inch each, so that weight of upper pipe ranks is not distributed onto couplings of lower ranks.

4.1.5 When transported by sea, pipe bundles shall not be placed in water inside the vessel's hold or in any other corrosive environment. Dragging of bundles along the piles or hitting bundles against hatches or rails is strictly forbidden.

4.1.6 When loading pipe bundles into railway cars or trucks, wooden girders (blocks) shall be provided for car floors or vehicle beds to ensure required distance between the products and uneven bottom of the vehicle. No blocks shall be placed under couplings.

4.1.7 Pipes from chromium and corrosion-resistant steel shall be packaged using wooden or plastic beds.

4.1.8 In order to avoid hitting of pipes against vehicle metal elements or protruding parts of neighbouring pipe bundles, it is recommended to use load platforms with protecting covers.

4.1.9 When attaching chromium and corrosion-resistant steel pipe bundles to loading platform or deck it is required to use nylon cables.

4.2 Handling operations

4.2.1 All handling operations with pipes shall be carried out with thread protectors screwed on pin and coupling ends.

4.2.2 Handling operations with pipe bundles shall be carried out only with the help of hoisting transportation clamps.

In case of manual unloading, rope slings shall be used and pipes shall be rolled along guides in parallel to the pile, avoiding quick movement and collision of pipe ends.

When using the crane, spreader beams with slings shall be used according to approved slinging diagrams.

4.2.3 Pipes shall not be allowed to fall down from heights or be picked up by the pipe end with a hook or be dragged or subjected to any other actions that might damage pin and coupling threads, surfaces or shapes.

4.2.4 Handling operations with chromium steel pipes shall be performed using nylon or steel harnesses with plastic braid. When using a forklift, gripping forks, frames and clamps with nonmetallic coating shall be used.

4.2.5 Handling operations for chromium steel pipes shall exclude collision of pipes.

4.3 Stockholding and storage

4.3.1 Pipe storage conditions shall comply with GOST 15150 for Group 4 (long-term storage) or Group 8 (short-term storage up to three months and service interruptions).

4.3.2 Pipes, equipment and spare parts storage in warehouses on facilities of production and technical servicing and completing, enterprises and entities shall be according to RD 39-7-904-83.

4.3.3 Pipe bundles shall be stacked on supports spaced in a manner avoiding sagging or thread connection damage. Rack supports shall be located in one plane and shall not sag under the pile weight. Rack bearing surface shall be minimum 11.8110 inch above the ground or floor.

**Pipe bundles shall not be stocked on the ground, rails,
steel or concrete floor!**

4.3.4 When several pipes bundles are stacked or not bundled pipes are stacked into several ranks, pipe bundles and pipe ranks shall be separated by at least three wooden blocks, with the thickness from 1.3780 to 1.5748 inch each, so that weight of upper pipe ranks is not distributed onto couplings of lower ranks.

The height of the pipe pile shall not exceed 9.8425 ft..

4.3.5 Stockholding of unbundled pipes is allowed provided vertical posts are installed in the racks.

4.3.6 If pipes are rolled on the racks, any movements at an angle to the rack axis shall be excluded as this may result in collision of pins and damage of thread connection or thread protectors.

4.3.7 During pipe storage, availability and integrity of thread protectors, as well as compound underneath and its expiration date shall be inspected. Pipe corrosion shall not be allowed.

4.3.8 During pipe storage before use for more than 6 months, the compound under thread protectors shall be renewed except for the pipes which thread connections are covered with thread compound of longer period of storage or with Green Well thread compound.

For this purpose, the following actions shall be performed:

- Unpack the package and roll the pipes;
- Remove thread protectors according to para. 5.3;
- Remove initial compound according to para. 5.4;
- Apply storage compound (Kendex OCTG, BESTOLIFE Storage Compound (BSC), Total Jet Marine, RUSMA storage compound, RUSMA-M3 or thread compound with storage properties),

with the expiration date of minimum 6 months – till the next compound renewal or pipe usage;

- Install the thread protectors that were previously removed, make sure they are cleaned from old compound, or install new thread protectors according to para 5.8;

- After completion of operation, package the pipes in compliance with packing list or store separately.

4.3.9 Pipes damaged during transportation, rejected during inspection, prepared for repair or awaiting a final decision shall be stored on separate racks with the corresponding information tags.

4.3.10 When stockholding of pipes from chromium steel, rack supports shall be equipped with wooden or plastic substrates.

4.3.11 Drilling site shall have a special area for pipe stockholding in compliance with above-listed requirements.

4.3.12 Required quantity of racks shall be installed at drilling site in order to provide for stockholding of full set of pipes.

While stacking onto racks it is important to consider the order of string running (if it is specified in the work instruction), to exclude the risk of additional reasorting.

5 Preparation of pipes for make-up

5.1 General provisions

Prior to lifting the pipes onto the rig site, proceed as follows:

- Perform visual inspection of pipes and couplings;
- Remove thread protectors from pipes and couplings;
- Remove storage compound from external and internal thread connections (when thread compound is used, its removal is not required, ref. 5.4.4);
- Inspect surfaces of external and internal thread connections;
- Drift pipes along the entire length;
- Measure the length of each pipe;
- Re-install clean thread protectors on pins and couplings.

5.2 Visual inspection

5.2.1 Visual inspection of pipes, couplings and thread protectors shall be performed in order to detect bent pipes, dents and damages.

5.2.2 Visual inspection of pipes and couplings shall be carried out with thread protectors screwed on.

5.2.3 Pipes, couplings and thread protectors with damages, discovered during visual inspection shall be put aside awaiting decision on their suitability for use.

Amount of damaged pipes shall be specified in the Product Quality Non-Conformity Protocol and all damaged areas shall be documented on photographs.

5.3 Thread protectors removal

5.3.1 Thread protectors shall be removed after thread connections are visually inspected.

5.3.2 Thread protectors shall be removed manually or using a special tong with one person's effort. In case of difficulties when removing thread protectors, heating of thread protectors with steam is allowed as well as striking slightly with a wooden hammer at a protector end to eliminate a possible distortion.

5.4 Compound removal

5.4.1 After removal of thread protectors, external and internal thread connections shall be cleaned from storage compound by hot soapy water or with a steam cleaner. It is recommended to supply water under pressure. In case of freezing temperature, compound may be removed by using a solvent (Nefras, white spirit or similar). After compound is removed, thread connection shall be purged with compressed air or cleaned with dry rags.

***Compound shall not be removed using
diesel, kerosene, salty water, barite or metal brushes!***

5.4.2 Barite or metal brushes can cause scratches on surfaces of sealing elements resulting in loss of tightness.

5.4.3 After compound is removed, thread connections shall be purged with compressed air or cleaned with dry rags.

5.4.4 When pipes are supplied with thread compound RUSMA-1 (3), RUSMA R-4 (3), RUSMA R-14 (3) under thread protectors, it is allowed to perform the first running and pulling operation with mill compound if mill thread protectors are screwed on and are not damaged. When thread protectors are screwed off, it is necessary to make sure that:

– The compound is free of foreign particles (if there are foreign particles, compound shall be removed according to 5.4.1, and reapplied according to 6.1);

- The compound is applied onto thread in an even layer (make the surface even and/or add the compound of the same type if necessary);
- The pipe was manufactured not more than 1 year ago according to the Certificate.

5.5 Thread connection inspection

5.5.1 Thread connection shall be inspected by the following specialists:

- Crews for tubing assembly;
- Companies specialized in tubing inspection;

When running tubing for the first time, representatives of the tubing supplier shall be present.

5.5.2 Under low light condition (twilight, night), individual portable light sources shall be used during inspection.

5.5.3 When inspecting pipe and coupling thread connections surfaces, make sure you pay due attention to the presence of:

- Damages resulting from pipes collisions or other impacts;
- Damages resulting from installation of thread protectors;
- Rust, corrosion or other chemical damages caused as a result of environmental exposure or due to aggressive agents.

5.5.4 Possible damages that might occur on thread connections surface before pipe and coupling putting into operation and the ways of the damages elimination are listed in Table 1 for defined areas of thread connections, indicated in Figure 1.

Thread area with imperfect profile thread on pipes (Area 1 on Figure 1a) has an unfinished surface of thread crests (black-crested threads), corresponding to the surface of pipe body, and interruption of the last thread turns.

Note - Surface quality of unfinished thread crests complies with the quality of pipe body surface.

The length of an area of pipe thread with perfect profile and of an area, on which no interruption of thread turns shall be, is determined in accordance with Table 2.

Table 1 - Types of possible damages of thread connections surface before putting into operation and methods of their repair

Surface area (Figure 1)	Type of damage	Damage repair method
1.2	Surface corrosion (rust), surface corrosion with the depth of not more than 0.0039 inch	Manual repair (removal) using non-metal brush with soft bristle or polishing paper with grain 0
	Pit corrosion more than 0.0039 inch deep	Not to be repaired
	Dents, nicks, grooves and other defects with the depth of not more than 0.0039 inch	Manual repair using needle file or polishing paper with grain 0
	Dents, nicks, grooves and other defects with the depth of not more than 0.0039 inch	Not to be repaired
3	Surface corrosion (rust), surface corrosion with the depth of not more than 0.0118 inch	Manual repair using needle file or polishing paper with grain 0
	Pit corrosion more than 0.0118 inch deep	Not to be repaired
	Dents, nicks, grooves and other defects with the depth of not more than 0.0039 inch	Manual repair using needle file or polishing paper with grain 0
	Dents, nicks, grooves and other defects with the depth of not more than 0.0039 inch	Not to be repaired
4	Pit corrosion of any depth	Not to be repaired
	Surface corrosion (rust), removed by buffing	Repair by buffing
	Grooves removed by buffing	Repair by buffing
	Dents, nicks and other defects of any depth	Not to be repaired

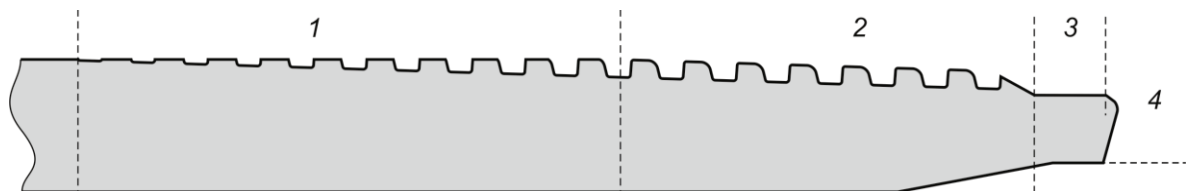

a) – Surface of external thread connection

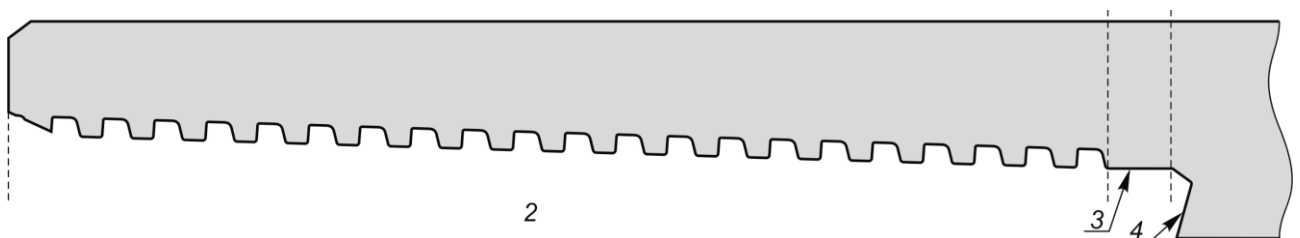

b) – Surface of internal thread connection

1 - imperfect profile of thread; 2 - perfect profile of thread;
 3 – cylinder groove or bore; 4 - seal and thread shoulders.

Figure 1

Table 2 - The length of an area of pipe thread with perfect profile and of an area without interruption of thread turns

In inches		
Pipe outside diameter, <i>D</i>	The length of an area of thread with perfect profile, not less than ¹⁾	The length of an area without interruption of thread turns, not less than ¹⁾
2 3/8	0.7638	2.2244
2 7/8	0.8858	2.3465
3 1/2	1.2598	2.7205
4	1.5709	3.0315
4 1/2	1.6535	3.1142
¹⁾ Measurement of pipe thread areas length are carried out beginning from pipe end-face.		

5.5.5 Determination of corrosion depth and defects shall be performed using:

– A mould taken from a detected defect using a special tape (X Coarse material of Testex company for defects up to 0.0039 inch deep, for deeper defects: X-Coarse Plus or equivalent one). Mould height shall be measured with a thickness gage, measurement accuracy shall be at least 0.0004 inch (PEACOCK G2-127 gage or equivalent one);

– Depth gage with a needle-type contact point (contact point diameter shall be maximum 0.0039 inch), measurement accuracy shall be at least 0.0004 inch (PEACOCK T-4 gage or equivalent one).

5.5.6 If any irreparable damages are detected on pipes, such pipes shall be rejected then and reported accordingly specifying pipes serial numbers, describing damages found with photos attached.

5.6 Drifting

5.6.1 Drifting shall be performed using a mandrel along the entire length of pipes. For drifting of pipes made of chromium and corrosion-resistant steels, polymer or aluminium mandrels shall be used.

5.6.2 During drifting, the pipe shall be positioned in such a manner as to avoid sagging. If any ropes or bars are used for the drifting process, they shall be clean. In case of freezing temperatures pipes shall be heated prior to drifting to remove snow and ice.

5.6.3 Pipe and drift shall be of the same temperature during drifting process.

5.6.4 Dimensions of the mandrel effective part shall comply with the ones specified in Table 3.

According to customer's request and in case of additional requirements in an order, use of special mandrels which sizes differ from those specified in Table 3 is allowed.

Table 3 – Dimensions of the effective part of mandrel

In inches		
Pipe outside diameter, D	Effective length of the drift, L_o	Diameter of the effective part of the drift, d_o
Up to 2 7/8 including	42.0079 ¹⁾	$d^{2)} - 0.0937$ (3/32)
above 2 7/8	42.0079 ¹⁾	$d^{2)} - 0.1252$ (1/8)
¹⁾ Drifts with the effective part 49,2126 inch are allowed to be used. ²⁾ d – pipe inside diameter		

5.6.5 The mandrel shall pass through the entire pipe, when pulled manually without significant effort.

5.6.6 Pipes rejected during drifting process, shall be put aside until further decision on their validity and recorded in product quality non-compliance report.

5.7 Measurement of length of pipes

5.7.1 Length of each pipe shall be measured from free (without a thread protector) coupling end face to free (without a thread protector) pin end face.

It is recommended to compare measured pipe length with the marked length. In case of discrepancies the measured length shall be marked on the pipe body with a marker or a chalk.

5.7.2 The total length of the string shall be calculated by the formula specified below

$$L = \sum L_{\phi} - n \Delta L \quad (1)$$

where L – the total length of the string;

$\sum L_{\phi}$ – the total length of all the pipes in a string, measured from pin end face to free coupling end face;

n – number of pipes in a string;

ΔL – decrease of pipes length during make-up according to Table 4.

Table 4 – Decrease of pipes length during make-up process

In inches	
Pipe outside diameter	Decrease of pipe length during make-up ΔL
2 3/8	2.7835
2 7/8	4.2795
3 1/2	4.3425
4	4.3622
4 1/2	4.5276

5.8 Thread protectors installation

5.8.1 After inspection and control, thread protectors or caps shall be re-installed on pin and coupling ends.

5.8.2 Before installation thread protectors shall be thoroughly cleaned and shall have no significant damages affecting protection of thread and seal against direct contact with exposure.

6 Make-up of pipes

6.1 Application of thread compound

6.1.1 To ensure optimum conditions for make-up and to avoid burrs of mating surfaces, thread compound shall be applied on all the surfaces of thread, thread seals and thread shoulders of pins and couplings.

The following types of thread compound are recommended: RUSMA-1 and its modifications, RUSMA R-4 and its modifications, RUSMA API Modified 1000, RUSMA API Modified, Bestolife API Modified, Bestolife 72733, Bestolife 2000, Bestolife API Modified HP/HT, Bestolife 2000 NM, JET-LUBE API Modified.

During make-up of pipes from chromium steels with the chrome content over 3 %, it is recommended to use RUSMA R-4 and RUSMA R-14 thread compounds and their modifications.

By agreement with the developer of the connection, other thread compounds that meet requirements of GOST R ISO 13678 and API RP 5A3/ISO 13678 are allowed.

6.1.2 Thread compound for make-up shall only be taken from original packages, delivered by the supplier, the container shall show name, batch number and manufacturing date.

Compound from packages without proper identification shall never be used.

It is prohibited to empty one package into another and to dilute the compound.

Compound applied shall be homogeneous, of ointment consistency, free from any solid inclusions (stones, sand, dry compound, fine chips, etc.).

Prior to use, check compound's expiration date on the package.

Never apply compound with expired shelf life.

6.1.3 Make sure you follow the recommendations specified below when using thread compound:

- Use the same compound (the same type) when assembling one casing string;
- Use a new compound package for each running, if the compound from opened package is used, make sure it is free from foreign inclusions;
- Stir the compound thoroughly before use;
- Warm up the compound before application in case of freezing temperatures.

Compound shall be stored in closed overturned packages at the temperature specified by the manufacturer. When storing partially unused compound, always specify the date of the first use on the package.

6.1.4 Thread compound shall be applied in an even and continuous layer on the whole thread surface, thread seals and thread shoulders of pins and couplings connections. Figures 2 and 3 demonstrate proper and improper application of compound.

Compound shall be applied only on thoroughly cleaned and dried surfaces of thread connection.

Never use metal brushes for compound application!

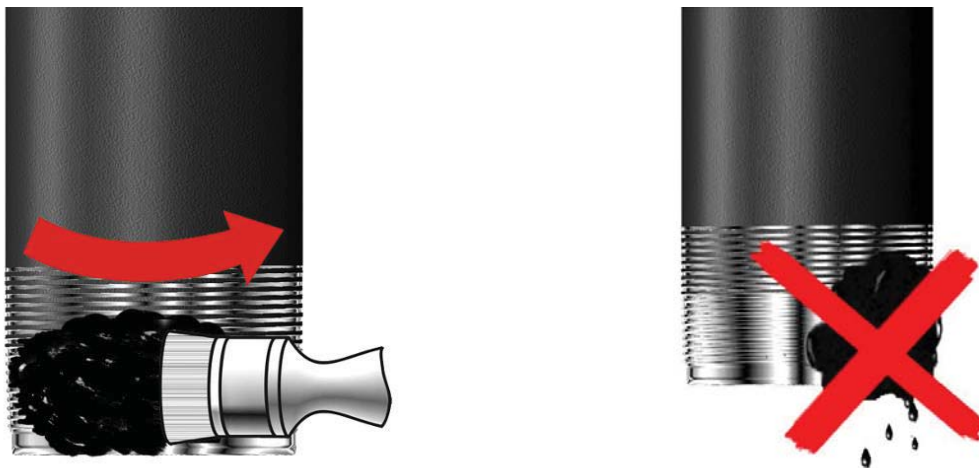

Figure 2

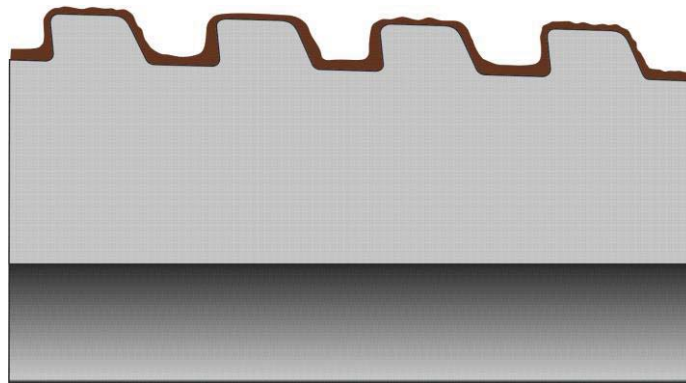

Figure 3

6.1.5 Required amount of thread compound shall be distributed between coupling and pin end as follows: two thirds shall be on the coupling end and one third shall be on the pin end.

Minimum and maximum compound mass m_{\min} and m_{\max} in gr for make-up of one thread connection shall be calculated as follows:

$$m_{\min} = 0.20 \times D \quad (2)$$

$$m_{\max} = 0.25 \times D \quad (3)$$

where m_{\min} is the minimum compound mass in gr rounded to an integral value;

m_{\max} is the maximum compound mass in gr rounded to an integral value;

D is an outside diameter of pipes, in mm, rounded to an integral value.

Example. The minimum quantity of thread compound required for make-up of one thread connection of a coupling and pipe with an outside diameter of 114.30 mm (4 1/2):

$m_{\min} = 0.2 \times 114 \approx 23 \text{ gr (0.81 oz)}$ with at least 16 gr (0.56 oz) per coupling and at least 7 gr (0.25 oz) per pin.

Note – calculated weight of compound is theoretical.

6.1.5 To determine the quantity of compound required for determined number of pipes, a package of compound with specified volume shall be used.

Prior to pipes running down the hole, make sure that required thread compound of one type is available.

6.1.6 Thread sealant can be used for make-up of pipes with crossovers or other string elements provided the below conditions are followed:

- Shoulder torque of thread shoulders is from 25% of optimum make-up torque and final make-up torque exceed shoulder torque by 20%;

- Shoulder torque of thread shoulders is higher than 80% of optimum make-up torque and it does not result from thread jamming or damage, and 20% of optimum make-up torque is applied after the shoulders interlock.

6.2 Running and pulling

6.2.1 Casing shall be assembled by a qualified personnel. Make-up of connection with the use of torque registration system and make-up diagram plotting is the method ensuring proper make-up and claimed by the manufacturer technical properties of the connection.

Methods of make-up inspection with the use of manometer of breakout tong, make-up triangle (transverse stripe) do not ensure proper make-up and can be used by the user at his own and sole discretion without any guarantees on behalf of PAO "TMK" to get the claimed by the manufacturer technical properties of the connection.

6.2.2 A special stab guide or bell guide is recommended for running and pulling operations (Figure 4). This device helps to align pin and coupling and prevent the connection from damage.

6.2.3 In order to decrease the risk of new damages during running and pulling operations, it is recommended to use pipe weight balancer.

In case of non-operating state of pipe weight balancer or its absence, a driller shall control constant weight on hook (within limits ± 100 kg (± 220.46 lb)) taking into consideration pipe weight.

6.2.4 While running a string of chrome steel pipes it is recommended to use an elevator and special wedge claws to avoid pipe body damages.

6.2.5 Rotary tongs or casing make-up system shall be equipped with a speed governor and shall ensure:

- at the initial stage - speed of make-up of not more than 2 rpm; safe entering of external thread into internal thread (reverse is allowed).
- at the stage of the main make-up - smooth rotation of a pipe at the speed of not more than 10 rpm;
- at the stage of rotation on shoulder - make-up speed of not more than 2 rpm and smooth rotation of a pipe without jerks and stops.

If break-out of thread connection according to para. 6.5 and casing make-up system use are required, rotary tongs shall be provided.



Figure 4

Rotary tongs shall be equipped with clamps for used pipe sizes to ensure adequate contact area with the pipe body. Clamps diameter shall be 1 % greater than pipe nominal outside diameter. Clamps shall be adjusted in such a way that they hold the pipe tightly and never slip.

For make-up and break-out of chromium steel pipes, the rotary tongs shall be equipped with non-metallic or non-injurious tong dies.

Prior to make-up, tongs shall be positioned as per Figure 5.

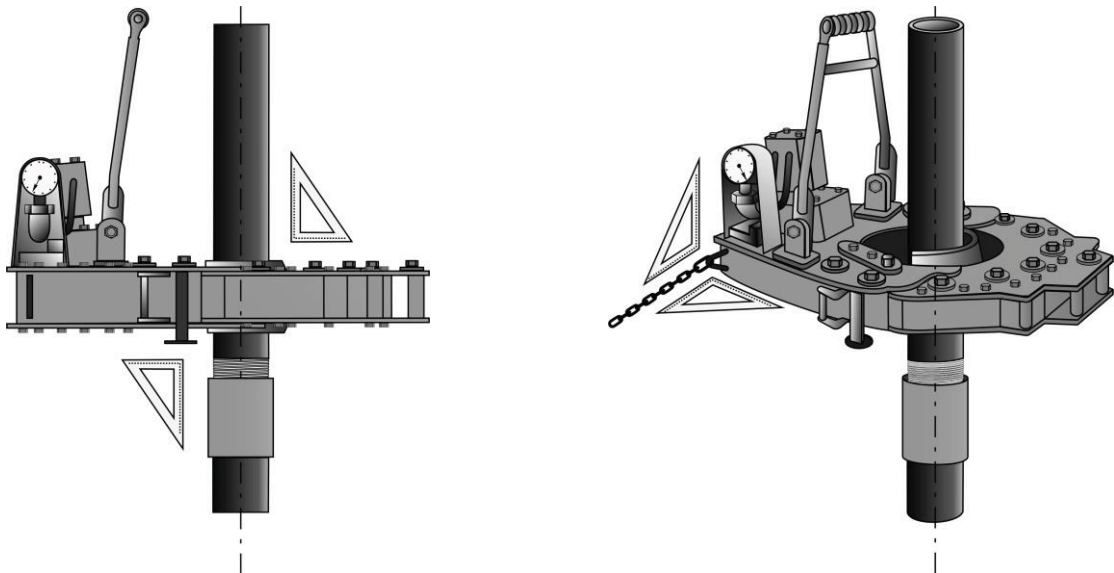

Figure 5

6.2.6 Make-up equipment shall ensure torque at least 30 % greater than recommended maximum make-up torque.

6.3 Assembly of string

6.3.1 Make sure thread protectors are secured in place prior to lifting pipes onto the rig floor.

Lifting pipes to the rig floor without thread protectors or end caps is not allowed!

6.3.2 Prior to assembly of the string, remove thread protectors or end caps and check surfaces of thread seals and thread shoulders of the free pin for any mechanical damage according to Figure 6.

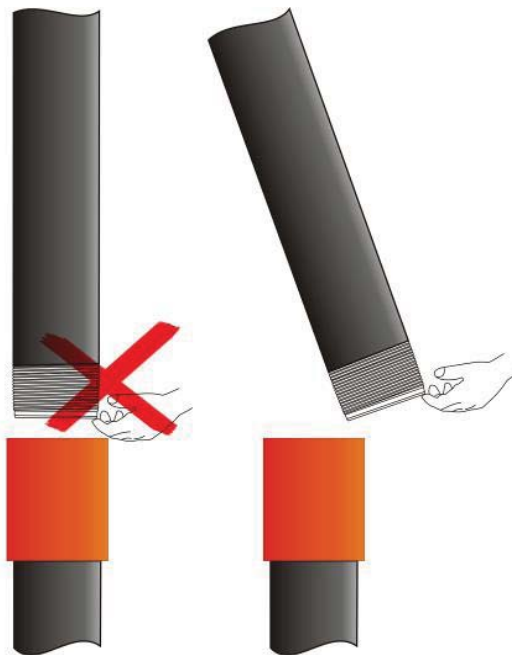

Figure 6

6.3.3 During make-up process, if a derrick man is absent, it is required to control alignment of upper pipe coupling end (decline) with lower pipe rotation axis and correct the situation timely by directing a driller accordingly (topdrive turn, elevator movements up and down, etc.) (Figure 7).

Maximum misalignment of connected pipes shall not exceed 0.7874 inch.

6.3.4 Compound shall be applied according to para. 6.1. It is recommended to perform air blasting of external and internal threads prior to compound application.

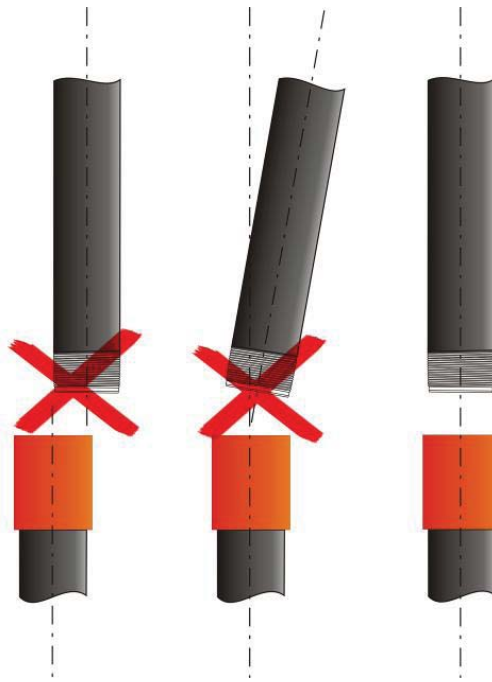

Figure 7

6.3.5 Make sure prior to make-up, that surfaces of thread, thread seals and thread shoulders with applied compound are free from mud or mud laden fluid with small contaminations, hindering tightness of connection. In case of mud or mud laden fluid on connection surfaces, clean them and apply thread compound again.

6.3.6 When stabbing a pin into a coupling, pin end face shall not hit coupling end face, pin sliding down into the coupling is not allowed.

6.3.7 The make-up torque for a thread connection shall be within the range from the minimum up to the maximum torques, specified in Table 5 for the corresponding size of pipes and grades.

If thread connection make-up with torque within the limits shown in Table 5 is not in compliance with specified requirements, M_{opt} may be corrected but not more than by $\pm 15\%$. At that, the values of M_{min} and M_{max} shall be corrected but not more than by $\pm 10\%$ of corrected M_{opt} .

6.3.8 During make up of pins and couplings made of steels of different grades, the make-up torque value shall be chosen according to the lowest steel grade of both pin and coupling.

Table 5 – Make-up torques

D, Inch	S, Inch	Torque, ft lb for steel grades																										
		J55, K55			N80, L80			C90			R95, C95,T95			C110, P110			Q125			Q135			TMK140			TMK150		
		M _{min}	M _{opt}	M _{max}	M _{min}	M _{opt}	M _{max}	M _{min}	M _{opt}	M _{max}	M _{min}	M _{opt}	M _{max}	M _{min}	M _{opt}	M _{max}	M _{min}	M _{opt}	M _{max}	M _{min}	M _{opt}	M _{max}	M _{min}	M _{opt}	M _{max}	M _{min}	M _{opt}	M _{max}
2 3/8	0.1902	1000	1200	1300	1200	1300	1500	1300	1500	1600	1400	1500	1700	1600	1800	1900	1700	1800	2100	1700	1900	2100	1800	2100	2300	1900	2100	2400
2 7/8	0.2169	1500	1600	1800	1600	1800	1900	1700	1800	2100	1700	1800	2100	1800	2000	2200	1800	2000	2200	2400	2600	2900	2400	2700	3000	2600	2900	3200
	0.2760	1700	1800	2100	1800	2000	2200	1900	2100	2400	1900	2100	2400	2100	2300	2500	2100	2300	2500	2700	2900	3200	2800	3100	3400	2900	3200	3500
	0.3079	1900	2100	2400	2100	2400	2600	2300	2500	2700	2300	2500	2700	2400	2700	2900	2400	2700	2900	3100	3500	3800	3200	3600	4000	3400	3800	4100
3 1/2	0.2161	2100	2300	2500	2200	2400	2700	2400	2700	2900	2400	2700	2900	2500	2800	3100	2500	2800	3100	3200	3600	4000	3400	3800	4100	3500	3900	4300
	0.2539	2100	2400	2600	2400	2600	2900	2500	2800	3100	2500	2800	3100	2700	2900	3200	2700	2900	3200	3400	3800	4100	3600	4000	4400	3700	4100	4600
	0.2890	2300	2500	2700	2400	2700	3000	2700	2900	3200	2700	2900	3200	2900	3200	3500	2900	3200	3500	3600	4000	4400	3800	4200	4600	4000	4400	4900
	0.3748	2600	2900	3200	2700	3000	3300	3000	3300	3700	3000	3300	3700	3200	3500	3900	3200	3500	3900	4000	4400	4900	4300	4700	5200	4400	4900	5400
	0.4299	3000	3400	3800	3200	3600	4000	3500	3900	4300	3500	3900	4300	3800	4200	4600	3800	4200	4600	4800	5300	5800	5000	5600	6200	5200	5800	6400
4	0.2260	2400	2600	2900	2500	2800	3100	2900	3200	3500	2900	3200	3500	3200	3500	3900	3200	3500	3900	3700	4100	4600	3900	4400	4800	4100	4500	4900
	0.2618	2600	2900	3200	2900	3200	3500	3200	3600	4000	3200	3600	4000	3600	4000	4400	3600	4000	4400	4200	4600	5100	4400	4900	5500	4600	5100	5600
	0.3299	3000	3400	3800	3400	3800	4100	3800	4300	4700	3800	4300	4700	4300	4700	5200	4300	4700	5200	5000	5500	6100	5200	5800	6400	5500	6000	6600
	0.4150	4200	4600	5100	4600	5200	5700	5200	5800	6300	5200	5800	6300	5800	6400	7100	5800	6400	7100	6900	7600	8300	7200	8000	8800	7500	8300	9100
4 1/2	0.2709	2900	3200	3500	3000	3400	3800	3300	3700	4100	3300	3700	4100	3500	3900	4300	3500	3900	4300	4500	5000	5500	4700	5200	5800	4900	5500	6000
	0.3370	3500	3800	4200	3800	4200	4600	4100	4500	4900	4100	4500	4900	4400	4800	5300	4400	4800	5300	5600	6200	6800	5800	6500	7200	6000	6700	7400
	0.5000	4000	4400	4900	4400	4900	5400	4700	5200	5800	4700	5200	5800	5000	5500	6100	5000	5500	6100	6400	7200	7900	6800	7500	8300	7000	7800	8600
<p>Note</p> <ol style="list-style-type: none"> The grades specified without types include all the types. Make-up with special couplings shall be performed with torques 20% less than the specified ones. When making-up pipes with the grades not specified in present Table, refer to the torque provided in regulatory documentation for these pipes. 																												

6.3.9 Make-up of pipes and couplings shall be performed with the use of make-up registering equipment, by make-up diagrams, at that it shall meet the requirements specified in Annex A.

6.3.10 Make-up without registering equipment shall be performed based on make-up torques and make-up mark applied on pin free end (Figure 8). A transverse stripe (in light paint) can be made on the pin instead of the make-up triangle, in such a case a triangular sign (in light paint).

When make-up is checked by triangle marking (transverse stripe), correct make-up is proved by alignment of coupling end face with the base of make-up triangle (transverse stripe near edge) on the pin with allowable deviation ± 0.0394 inch.

Above inspection methods are secondary, and they do not provide for assessment of make-up quality.

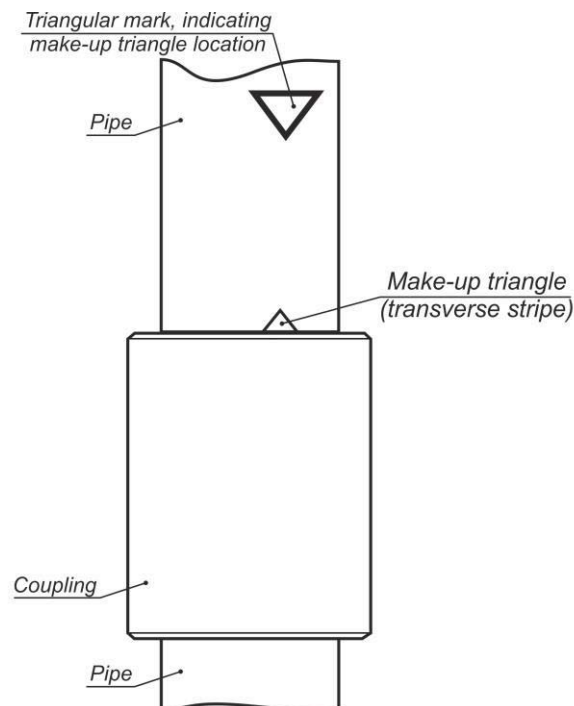

Figure 8

6.3.11 At the initial stage of assembling it is recommended to perform the first two revolutions of pipe using strap tongs (chain tongs are allowed for use only with the safe gasket which is set between the pipe body and the tong thus avoiding pipe body damage) to assure connection of external and internal threads, i.e. entering of external thread profile in mating profile of internal thread.

At this stage pipe reversal half-revolution is allowed for steady continuation of make-up without threads overlapping and high-quality assembly.

6.3.12 When making-up chromium steels pipes, the first two turns shall be carried out manually, or strap tongs can be used (Figure 9). Chain tong is allowed for use only under condition that the pipe body is secured from damage (e.g. by the safe gasket which is set between the pipe body and the tong).



Figure 9

6.3.13 Make-up rotation speed during connection make-up with the rotary tong shall correspond to the values specified in Table 6.

Table 6 – Rotation speed during make-up

Start of make-up		End of make-up (rotation on shoulder)
First two turns	Further turns	
Speed maximum 2 rpm, Better manually	Speed maximum 10 rpm	Speed maximum 2 rpm

6.3.14 Even longitudinal movement of the pipe resulting from gradual increase of number of engaged revolutions shall be watched, significant warming of the connection (not more than 122°F of the ambient temperature) shall not be allowed.

6.3.15 Make-up shall not cause significant mechanical damages like galling, jamming or other imperfections on pipe and coupling body.

The outer surface of coupling shall be free of damages with the depth larger than 0.5% of the coupling nominal outside diameter.

Damages from tong clamps are allowed on the pipe outer surface provided that the actual pipe wall thickness, taking into account depth of the damage, shall be not less than 87.5 % of the nominal pipe wall thickness.

After make-up of chromium steel pipes, the trace depth on the pipe body shall be not more than 0.0079 inch.

6.3.16 When using hydrotongs with back up, the following conditions shall be observed:

During the first rotations (better manually, using a chain tong), back up shall be opened, and make-up shall be performed

without make-up torque increase. At that it is possible to make horizontal movements of hydrotongs (right/left) to prevent thread bite during make-up.

Upon increase of make-up torque (on the last 3 turns), it is required to stop, fix the back up on lower pipe body and continue make-up.

6.3.17 When the value of the final make-up torque equal to M_{max} value is achieved, turning of coupling from the side of mill connection is allowed, if the make-up diagram has not been changed (Figure 10). The final make-up torque values shall be within M_{min} to M_{opt} limits in order to reduce the probability of turning.

6.4 Make-up inspection by the make-up diagram

6.4.1 General provisions

6.4.1.1 The shoulder torque M_{sh} of thread shoulders (box shoulder and pin shoulder) shall be within the range between 5% and 80% of the optimum make-up torque M_{opt} .

6.4.1.2 The final make-up torque shall be within the range from the minimum M_{min} to the maximum M_{max} make-up torques.

6.4.1.3 Typical cases of make-up diagram shape non-compliance are shown in Figures 11 – 15.

6.4.1.4 If the make-up curve is of improper shape, giving rise to doubt in make-up quality, break out the connection.

After break-out the surface of pin and coupling thread connections shall be cleaned from compound and visually inspected.

If no surface damages and (or) shape distortion (decrease of pin or box shoulder inside diameter, sagging on coupling inside surface) are observed, thread compound shall be applied on thread connections of pins and couplings again in accordance with the requirements of 6.1, the settings of equipment, alignment of made-up pipes shall be checked, make sure there is no slippage of clamp jaws and make-up the connection again.

If surface damages are observed and can be repaired in accordance with para 6.5.9. after repair thread compound shall be applied on pin and coupling connections in accordance with the requirements of para 6.1, the settings of equipment, alignment of made-up pipes shall be checked, make sure there is no slippage of clamp jaws and make-up the connection again.

If the damages observed cannot be repaired it is necessary to reject the connection.

If the shape of the make-up diagram after re-make-up is similar to the shape of the first make-up diagram, the pipe shall be laid aside and make-up with another pipe shall be performed. The laid aside pipe is allowed to be used for further make-up if no damages are observed or the damages are repaired. Reapply thread compound of the appropriate type and quality, check the settings of equipment.

Pipes on which pin or coupling were made up three times with replacement of counter pipe and with make-up diagrams of a wrong form shall be rejected.

6.4.2 Correct make-up diagram

6.4.2.1 If make-up is performed correctly and all the thread connection geometric parameters comply with the established requirements, the make-up diagram clearly shows defined areas, which correspond to torque increase due to mating of thread surfaces (area I), thread and sealing element (section II), thread, sealing and shoulder elements (area III).

6.4.2.2 The torque increase on the first revolutions of make-up corresponding to the initial mating of thread shall be smooth and even. Torque shall increase upon further mating of thread and mating of sealing elements. The moment of shouldering is followed by sharp increase of torque thus confirming correct process of make-up. Value of torque increase from the moment of the connection shouldering shall be at least 737.56 lb/ft (1000 Nm) per 0.015 of rotation.

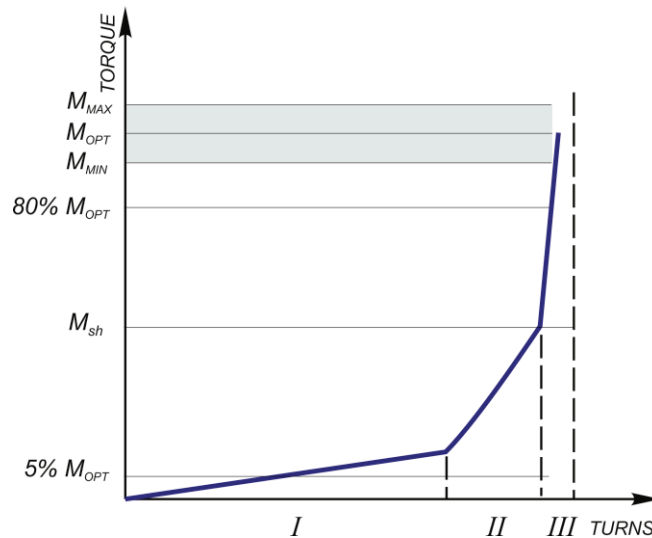

Figure 10

6.4.2.3 Depending on the rotary tong used, its adjustment, and other factors, the make-up diagram (especially in area I) can show areas with insignificant deviations from the straight line: oscillations, leaps, etc. Such deviations shall be deemed acceptable, provided that peak values and shoulder torque M_{sh} value are not exceeded,

and it is possible to track areas of mating of thread surfaces, seals and shoulders on the diagram.

6.4.3 Make-up diagram when torque increase stops

If at the final step of make-up procedure torque increase stops and there appears a horizontal area (area IV, Figure 11), but no slippage of clamp jaws is observed, actions shall be taken according to para 6.4.1.4.

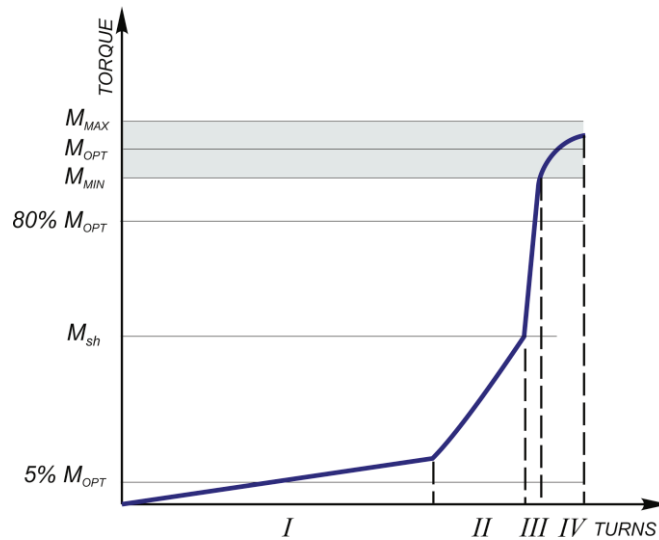

Figure 11

6.4.4 Make-up diagram when torque is low

Too low value of shoulder torque (M_{sh}) (below 5% of M_{opt}) on the make-up diagram (Figure 12) may result from:

- Application of wrong type of compound;
- Compound contamination or its poor storage conditions;
- Defects of load sensor.

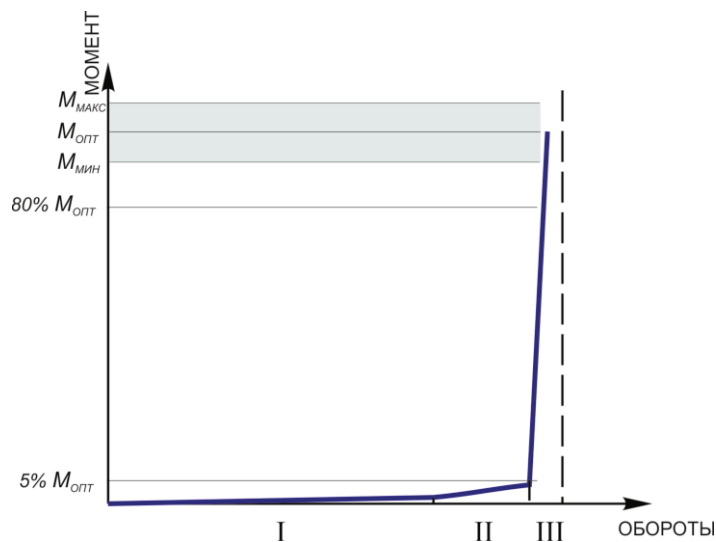

Figure 12

If the make-up curve is of improper shape, the following actions shall be taken according to para 6.4.1.4.

6.4.5 Make-up diagram when torque is high

Too high value of shoulder torque (M_{sh}) (over 80% of M_{opt}) on the make-up diagram (Figure 13) may result from:

- Damage of thread and/or thread seals;
- Improper thread cleaning;
- Application of wrong type of compound;
- Thread compound contamination or high density of thread compound (for example, at low temperatures);
- Defects of load sensor.

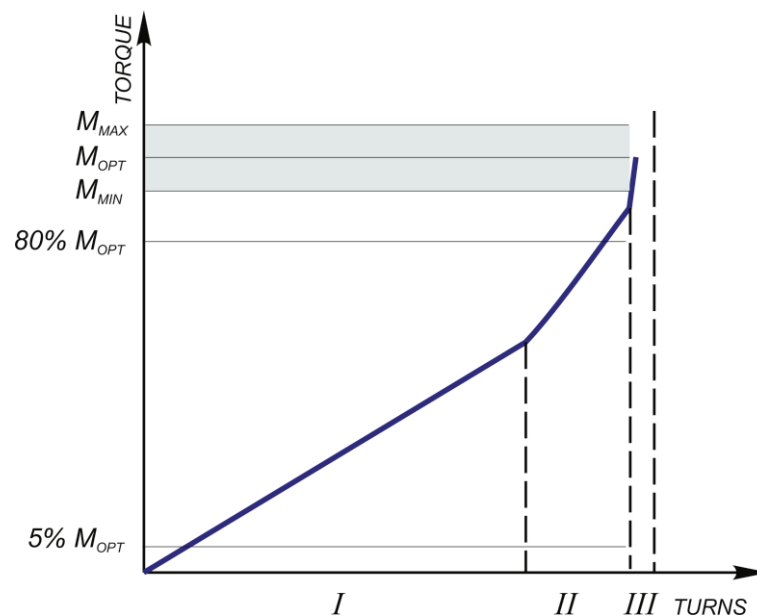

Figure 13

If the make-up curve is of improper shape, the following actions shall be taken according to para 6.4.1.4.

6.4.6 Make-up diagram with torque leaps

Torque leaps on the make-up diagram (Figure 14) may result from:

- Uneven application of thread compound;
- Misalignment of coupling make-up equipment;
- Insufficient force of rotation on shoulder;
- Slippage of clamp jaws.

Such a diagram is considered good and may be accepted according to requirements specified in para. 6.4.2.3.

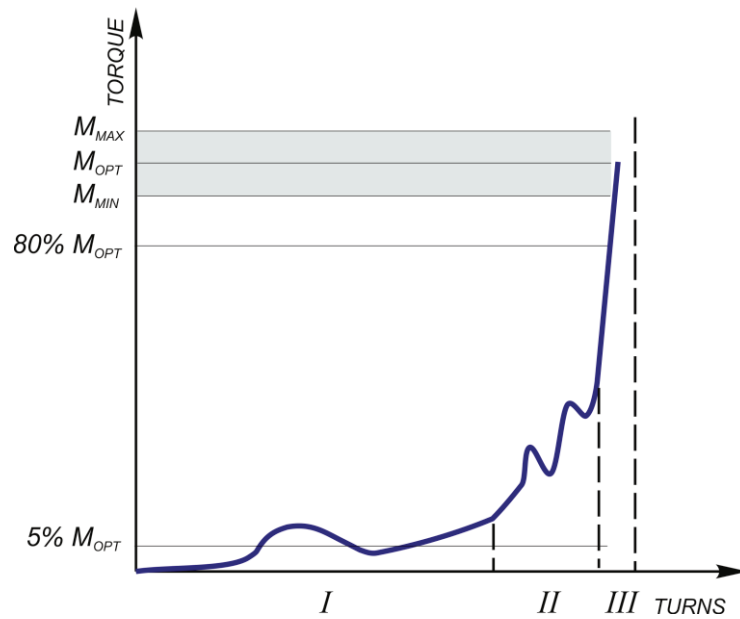

Figure 14

In case of any doubts concerning the make-up quality, the following actions shall be taken according to para 6.4.1.4.

6.4.7 Make-up diagram with a wave-like effect

Make-up curve with a wave-like effect (Figure 15), may result from:

- Improper thread cleaning;
- Thread compound contamination or high density of thread compound (e.g. at low temperatures);
- Excess of compound.

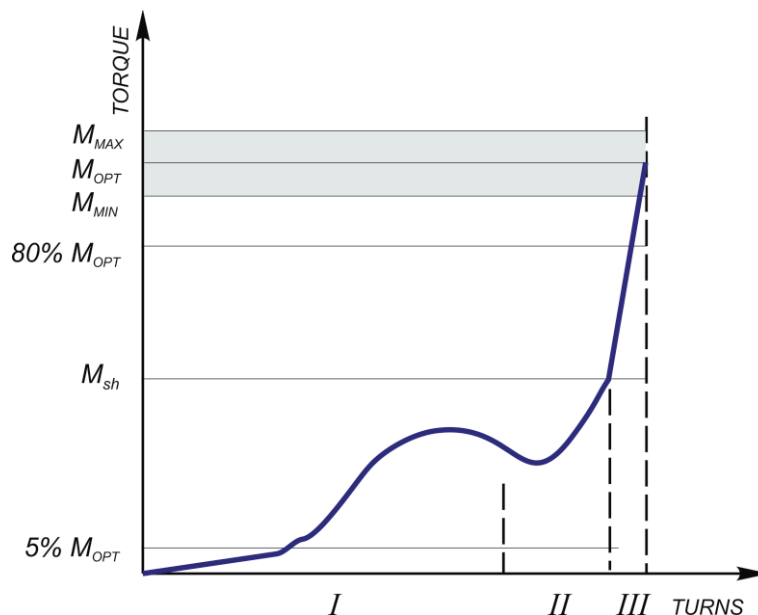

Figure 15

Such a diagram is considered good and may be accepted provided that requirements specified in para. 6.4.2.3 are met.

In case of any doubts concerning the make-up quality, the following actions shall be taken according to para 6.4.1.4.

6.5 Break-out of string

6.5.1 When the string is being pulled out of the well, pin end faces are not allowed to hit against coupling end faces.

6.5.2 Even longitudinal movement of the pipe resulted from gradual increase of number of engaged turns, shall be watched when the connection is broken-out.

A driller fixes the weight on a hook load free, provides tension within 100÷150 kg (220.5÷330.7 lbs), and tries to maintain these values in the process of breaking-out. On the last turn pipe moving up shall be stopped in order to fix thread run-out (a click) and after that the pin shall be moved out of the coupling.

6.5.3 Prior to break-out, the rotary tongs shall be positioned as per Figure 5.

6.5.4 Break-out torque shall provide for the connection disassembly.

Reduce of thread connection break-out torque by 20% relative to the recommended optimum make-up torque M_{opt} is allowed.

6.5.5 Speed of connection break-out by rotary tong shall correspond to the speed, specified in Table 7.

Table 7 – Speed of thread connection break-out

Start of break-out		End of break-out
First two turns	Further turns	
Speed maximum 2 rpm,	Speed maximum 10 rpm	Speed maximum 2 rpm

6.5.6 Make-up shall not cause significant mechanical damages like galling, jamming or other imperfections on pipes and couplings body.

The outer surface of couplings shall be free of damages with the depth larger than 0.5% of the couplings nominal outside diameter.

Damages from tong clamps are allowed on the pipe outer surface provided that the actual pipe wall thickness, taking into account depth of the damage, shall be not less than 87.5% of the nominal pipe wall thickness, the damage depth on the outer surface of pipes from chromium and corrosion-resistant steels shall be not more than 0.0079 inch.

6.5.7 When the string is disassembled, immediately after break-out or repair thread protectors shall be installed on pins and couplings ends.

6.5.8 If it is necessary to store pipes after string disassembly, the following preparations shall be carried out:

- Visual inspection of pipes and couplings body for significant mechanical damages (see 6.5.6);

- Cleaning of external and internal thread connections from compound and contaminations (ref. para. 5.4);

- Visual inspection of thread, seal and thread shoulders surface of pins and couplings thread connections (see 6.5.9). In case of any damages detection perform the corresponding repair or reject the pipes and couplings;

– Cleaning of thread protectors from the compound and contaminations applied (ref. para. 5.8);

– Application of storage compound Kendex OCTG, BESTOLIFE Storage Compound (BSC), Total Jet Marine, RUSMA storage compound, RUSMA - M3 or thread compound with storage properties on thread connections of pins and couplings and installation of thread protectors according to para. 5.8.

6.5.9 Possible damages that might occur on surface areas of thread thread seals, thread shoulders of external and internal thread connections after make-up - break out and the ways of their elimination are listed in Table 8 and in Table 17.

Table 8 - Types of possible damages of thread connections surface after make-up - break out and methods of their repair.

Surface area (Figure 16)	Type Of Damages	Extent of damage As per time allowed for repair, but not more than	Method of repair
1, 2	irregularities Of profile (peaks and roots, figure 17)	Light damages Which can be removed within Not more than 10 minutes	Manual repair (removal of profile peaks up to the level of joining thread turn surface) using polishing paper with grain 100÷150 micron
		Moderate damages - which can be removed within Not more than 10 minutes	Manual repair (removal of profile peaks up to the level of joining thread turn surface) using a needle file No.2, No.3, and polishing paper with grain 100÷150 micron for further treatment
		Severe damages - which can not be removed within 10 minutes	Not to be repaired
1, 2, 3	Dents, nicks, Tears, grooves and other defects	Light damages Which can be removed within Not more than 10 minutes	Manual repair (removal) using polishing paper with grain 100÷-150 micron
		Moderate damages - which can be removed within Not more than 10 minutes	Manual repair (removal) using a needle file No.2, No.3, and polishing paper with grain 100÷-150 micron for further treatment
		Severe damages - which can not be removed within 10 minutes	Not to be repaired
4	Grooves	light damages - which can be removed within Not more than 10 minutes	Repair (removal) by buffing
		Moderate and severe damages - which can not be removed within 10 minutes	Not to be repaired
	Dents, nicks, Tears and other defects of any depth	Damages of any extent	Not to be repaired

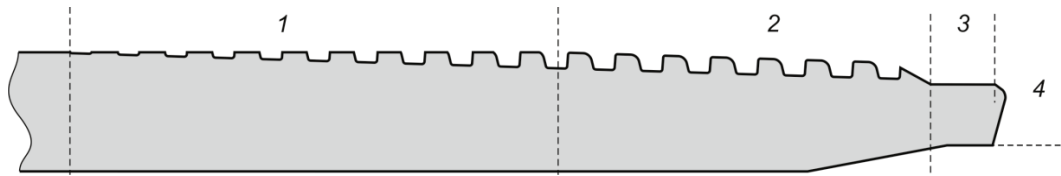

a) – Surface of external thread connection

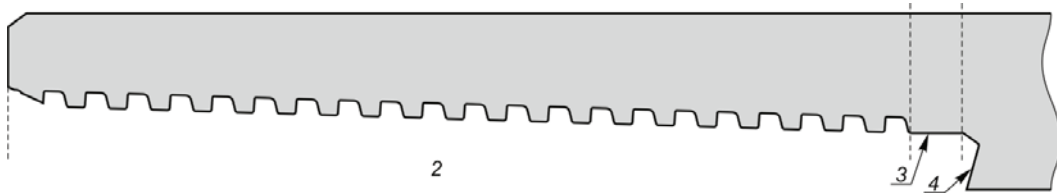

b) – Surface of internal thread connection

1 - imperfect profile of thread; 2 - perfect profile of thread;
 3 – cylinder groove or bore; 4 - seal and thread shoulders.

Figure 16

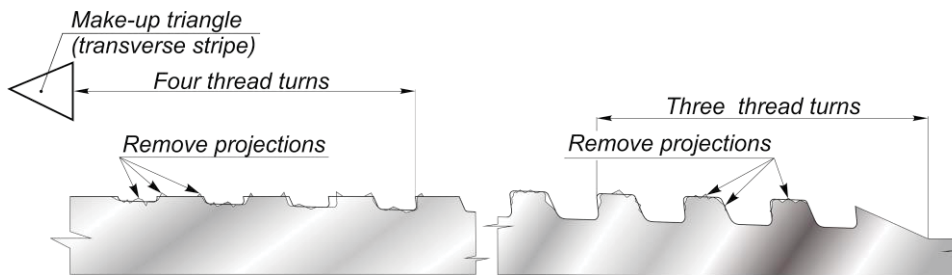

a) – Surface of external thread connection

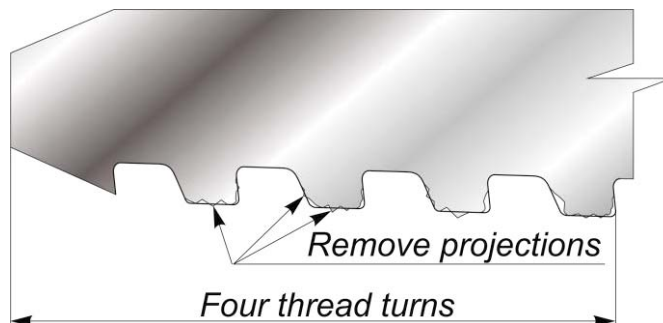

b) – Surface of internal thread connection

Figure 17

6.6 Make-up inspection by make-up triangle

When make-up is checked by triangle marking (transverse stripe), correct make-up is proved by alignment of coupling end face with the base of make-up triangle (transverse stripe near edge) on the pin with allowable deviation ± 0.0394 inch.

7 Developer’s warranty

Provided that the present recommendations are met, TMK UP FMT thread connection shall withstand at least 9 make-up and break-out cycles preserving the same technical characteristics.

Annex A (mandatory)

Equipment for make-up registration

TMK UP FMT thread connection shall be made-up using equipment for make-up registration and saving of make-up diagram (make-up curve) in a graphical or electronic format.

The make-up curve is plotted by torque values (vertical axis) and the number of revolutions (horizontal axis), which shall be linear scaled. Only last two revolutions are recommended to be recorded on the diagram, since torque increases at make-up completion.

When using a computer, a make-up diagram shall have the following characteristics:

- Sufficient resolution (at least 800×600 pixels) for accurate display of the curve profile. The display screen shall be with the diagonal size of at least 9.8425 inch, and the make-up curve shall occupy at least 80 % of the screen area;

- Display of minimum and maximum torque with horizontal lines (if required, optimum torque shall be displayed);

- Display of minimum and maximum shoulder torque as horizontal lines;

- Automatic and manual determination of shoulder torque of thread shoulders;

- Display of rig floor number of each make-up;

- Date and time display for each make-up;

- Availability of comments;

- Display of company-customer name, well number, pipe outside diameter and wall thickness, weight, steel grade, type of thread connection, thread compound data and pipe manufacturer;

- When applicable, superimposing of the latest make-up curve over the curves of previous satisfactory make-up diagrams;

- When applicable, display of make-up speed in rpm, either on the make-up curve or on a separate graph.

Acceptance or rejection of make-up operations shall not be based on displayed make-up results. Correctness of make-up shall be confirmed by a competent specialist.

***Prior to running the casing downhole
the calibration certificate with the latest and next planned equipment
calibration dates shall be checked!***

Annex B

(mandatory)

Requirements to safety upon tubing operation

B.1 Safety Ensuring

Measures to ensure safety during tubings operation, including their putting into operation, technical maintenance, all types of repair, periodical diagnostics, tests, preservation are determined by the company that uses the equipment, consisting of tubings.

B.2 Specified service life rate

The specified service life of tubings shall be at least 365 days and nights since the moment of their putting into operation subject to compliance with the requirements of the present guidelines for use.

When the service life of tubings is expired, the decision on their inspection and determination of new service life is made by the company that uses the equipment consisting of tubings.

B.3 list of critical failures

Critical failures during tubings operation are loss of tightness and thread connection or pipe integrity as a whole.

Critical failures may result from actions of the personnel connected with maintenance of the equipment, consisting of tubings, and related to the non-compliance with the requirements of the present guidelines for use,

B.4 Actions of personnel in case of failure or accident

In case of critical failure or accident the personnel connected with maintenance of the equipment, consisting of tubings, shall perform the following actions:

- inform the executives about failure or accident immediately;
- take measures to eliminate failure or accident and inform the executives about it.
- After elimination of failure or accident it is required to report briefly and exactly on the incident in the operator shift log, specifying the place, reason of failure or accident, measures taken to eliminate them.

Works on elimination of failure or accident shall be performed according to the plan worked out by the company than uses the equipment, consisting of tubings.

B.5 Criteria of limit states

B.5.1 Wall thickness loss and internal surface state

The key factors which determine the limit state of tubings are considered to be wall thickness loss and internal surface state.

Decrease in pipe wall thickness is stipulated by metal loss usually on pipe internal surface as a result of mechanical wear or galling, caused by abrasive effect of the extracted products. Decrease of pipe wall thickness loss may result in uniform pipe wall wear or local mechanical damages.

Deterioration of pipe internal surface state is stipulated by corrosion environmental exposure, under conditions of which recovery is performed.

Maximum allowable pipe wall thickness loss (prior to decommissioning) - is 85 % of the nominal wall thickness.

B.5.2 Evaluation of validity

Evaluation of tubings validity for further operation requires inspection of the wall thickness loss and pipes internal surface state to determine resistance to crumple, burst, tensile and corrosion effect, and shall be performed in compliance with the regulatory documentation on pipes.

B.6 Decommissioning and utilization

Decommissioning of pipes shall be performed by the company that uses the equipment, consisting of tubings, if the casings limit state criteria, specified in para 5.5, B,2 and B.5 of the present guidelines for use, are achieved. Decision on utilization of the tubings shall be made up depending on the terms and conditions of well abandon.

B.7 Employee qualification

Employee involved in maintenance of the equipment, which includes the tubings, shall have professional training of not lower than advanced education.

Prior to putting pipes into operation the employee shall be acquainted with the casings specifications and with the present guidelines for use.